



sonim[®]

XP5plus

USER GUIDE



GENERAL INFORMATION

Copyright © 2022 and 2021 Sonim Technologies, Inc.

Sonim and the Sonim logo are trademarks of Sonim Technologies, Inc. Other company and product names may be trademarks or registered trade-marks of the respective owners with whom they are associated.

MANUFACTURER'S ADDRESS

6500 River Place Blvd. Building 7, Suite 250, Austin,
TX 78730, USA
Tel: 1-650-378-8100

SONIM SUPPORT INFORMATION

For additional product and support information, visit www.sonimtech.com or contact our Sonim Customer Experience Center at 1-833-MY-SONIM (1-833-697-6646), 24-hours a day Monday to Friday, 9am-6pm Saturday & Sunday, Eastern time.

FirstNet users call 1-855 FIRST-SONIM
(1-855-347-7876), 24 hours a day, 7 days a week.

WARRANTY



Sonim devices are covered by a 3-Year comprehensive warranty. The battery is covered by a 1-year limited warranty.

Congratulations on the purchase of a Sonim XP5plus (XP5900) mobile phone! This phone has an intuitive feature-rich user interface, which allows you to make the best use of offered functions.

PHONE MODELS COVERED

This user guide covers Sonim XP5plus phone with the model number XP5900.

Table of Contents

GENERAL INFORMATION 2

Warranty.....	2
Sonim Support Information	2
Phone Models Covered.....	2

GETTING STARTED 5

What is in the Box?.....	5
Phone Specifications.....	5
SIM Card.....	6
Inserting the SIM Card.....	6
Inserting the Memory Card.....	7

USING YOUR SONIM XP5PLUS DEVICE 8

Switching on the Phone	9
Phone Operations without a SIM card	9
Managing Home Screen.....	9
Key Description	9
Notification Bar Icons	9
Capturing a Screenshot.....	10
To Change the Input Language	10
Text Entry Options.....	11

HOME SCREEN MENU OPTIONS 12

Wallpaper	12
Search.....	12
Home Screen Shortcuts.....	12
System Settings.....	12
Manage Apps.....	12

QUICK SETTINGS 13

Wi-Fi.....	13
Data.....	13
Bluetooth.....	13
Flashlight	13
Airplane Mode.....	13
Profiles	13

MISSED EVENTS 13

NETWORK & INTERNET SETTINGS 14

Wi-Fi.....	14
Mobile Network.....	15
Airplane Mode.....	15
Hotspot and Tethering.....	15
Data Saver	16
VPN	16
Private DNS	16

CONNECTED DEVICES 17

Bluetooth.....	17
----------------	----

APPS & NOTIFICATIONS 18

Apps Info	18
Default Apps	18
Permission Manager.....	18
Wireless Emergency Alerts.....	18
Special App Access.....	18

BATTERY SETTINGS 19

Battery.....	19
--------------	----

DISPLAY SETTINGS 19

Display	19
---------------	----

SOUND SETTINGS 20

Sound.....	20
------------	----

STORAGE SETTINGS 22

Storage.....	22
--------------	----

PRIVACY SETTINGS 22

Privacy	22
---------------	----

LOCATION SETTINGS 23

Location	23
----------------	----

SECURITY SETTINGS 23

Security	23
----------------	----

ACCESSIBILITY SETTINGS	24	BROWSER	34
Accessibility	24	Browser	34
SYSTEM SETTINGS	25	CAMERA	35
Home Screen Shortcuts	25	Camera	35
Programmable Keys	25	GALLERY	35
Languages & Input	25	Gallery	35
Date & Time	25	APPLICATIONS	36
System Update	26	Downloads	36
Reset Options	26	Backup and Restore	36
ABOUT PHONE	26	Voice Commands	36
MANAGING CONTACTS	27	Clock	36
Adding Contact for the First Time	27	Calculator	36
Viewing Contact Details	27	Sound Recorder	37
Sending a Message from Contacts	27	File Explorer	37
Dialing a Number from Contacts	27	FM Radio	37
Editing the Contact Details	27	Music	38
Managing Contact Settings	28	Calendar	38
Deleting a Contact	28	SIM Toolkit	38
MANAGING CALL SETTINGS	29	Note	38
Making a Call	29	Knob Version Options	38
Dialing a Number via Contact	29	Programmable Keys Additional Options	39
Adding a Contact from Home Screen	29	SAFETY AND REGULATORY	
Viewing Call History	29	INFORMATION	40
Deleting Call History	29	Environment Warning	40
Speed Dial Settings	29	Safety Warning	40
Call Settings	29	Avoid Extreme Temperature	41
SENDING MESSAGES	31	Personal Medical Devices	41
Sending SMS/MMS Message	31	Child Safety	41
Search	31	Emergency Calls	41
Wireless Emergency Alerts	31	Battery Usage	42
Message Settings	31	Guideline for Headphone and Earphone	43
Deleting Messages	32	HAC Rating	44
SONIMWARE™ SCOUT	33	Radio Frequency Energy	44
Setup	33	FCC Interference Statement	45
Utilities	33	FCC Compliance Statement	45
Support	33	ISED RF Exposure Statement (IC)	45
HAZARDOUS LOCATION USAGE	46	INDEX	47
Warnings	46		
Certification	46		

GETTING STARTED

WHAT IS IN THE BOX?

The list of items in the Sonim XP5plus phone box are:

- Sonim XP5plus
- Battery
- SIM Card
- Wall Charger
- USB-C Cable
- Screwdriver
- Battery Cover
- Quick Start Guide
- Accessory Guide

PHONE SPECIFICATIONS

FEATURE	DESCRIPTION	
Chipset	Qualcomm SM6115	
Band	North America	Roaming
	<ul style="list-style-type: none"> • UMTS: II, IV, V, • GSM 850,1900MHz • LTE: B2, B4, B5, B7, B12, B13, B14, B25, B26, B29, B30, B41, B66, B71 (B41 HPUE Power Class 2) 	<ul style="list-style-type: none"> • UMTS: I • GSM 900, 1800MHz • LTE: B1, B3, B8, B39, B40
Down link CA	CA_2A-2A, CA_2A-4A, CA_2A-5A, CA_2A-12A, CA_2A-13A, CA_2A-14A, CA_2A-66A, CA_2A-71A, CA_2C, CA_4A-4A, CA_4A-5A, CA_4A-12A, CA_4A-13A, CA_4A-71A, CA_5A-5A, CA_5A-41A, CA_5A-66A, CA_5B, CA_12A-66A, CA_13A-66A, CA_14A-66A, CA_25A-25A, CA_25A-26A, CA_26A-41A, CA_41A-41A, CA_41C, CA_66A-66A, CA_66A-71A, CA_66B, CA_66C, CA_2A-29A, CA_29A-66A, CA_29A-30A	

FEATURE	DESCRIPTION
Wi-Fi	Dual band, 802.11 a/b/g/n/ac with hotspot function excluding Wi-Fi 5G band 2/3
Memory	16GB Bytes eMMC + 2GB Bytes LPDDR, Micro SD up to 512GB
Languages Supported	English and Spanish
Battery	Removable Li-ion battery, 3.85V, 3500mAh
CONNECTIVITY	
Bluetooth	BT5.0/BLE (Low Energy)
SMS/MMS	Support SMS and MMS
GPS	GPS/aGPS, GLONASS
PHYSICAL CHARACTERISTICS	
Operating Temperature	-20°C to +55°C (-4°F to 131°F)
Protection Class	IP68 & IPX9K
Size	With knobs: 163.7 x 65.9 x 21 mm Without knobs: 148.7 x 65.9 x 21 mm
Weight	With knobs: 284g Without knobs: 275g
Dedicated Keys	PTT Key, Emergency Key, Programmable Keys
Ports	USB Type C port, SecureAudio™ Connector
DISPLAY	
SIZE	2.8 inches
Resolution	240x320
Outdoor Visibility	Yes
Capacity	262K
AUDIO	
Microphone	2 Mics with noise and echo cancellation
Speaker	Dual front-facing loud speakers with smart PA. Supports HD voice and wide band

FEATURE	DESCRIPTION
MULTIMEDIA	
Audio Formats	AAC,AAC+,AAC+ V2,MP3,AMR-NB, AMR-WB, FLAC,Vorbis, APTX
Video Formats	3GPP,MP4,AVI,MOV, MPEG-4,H.263,H.264,H.265,VP8,VP9
FM Radio	Wired headset for antenna is required
Camera	8MP Rear Facing

 All knobs features are not applicable for the non-knobs variant devices.

Flashlight	Yes, also used for camera flash.
-------------------	----------------------------------

 If Flash notification alert is enabled, when battery is above 20% level, you can use camera flashlight for missed events.

SIM CARD

The SIM (Subscriber Identity Module) card associates your network services (for example, phone number, data services etc.) with your phone.

The Sonim XP5plus device comes with Dual SIM card and Memory card trays.

Note: The phone has two SIM slots and a SIM can be inserted in either SIM slot. Due to carrier restrictions, when two SIMs are present, only the SIM card in Slot 1 is active.

INSERTING THE SIM CARD

1. UNSCREW COVER

Use the included screwdriver to unscrew the battery cover screw on the back of the phone.

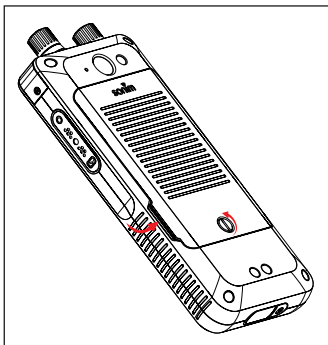

2. LIFT THE COVER

Lift the back cover to reveal the battery slot.

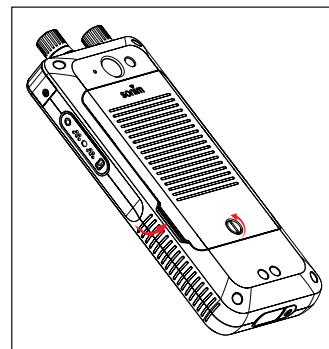

3. REMOVE THE BATTERY

After removing the back cover lift the battery from the battery compartment.

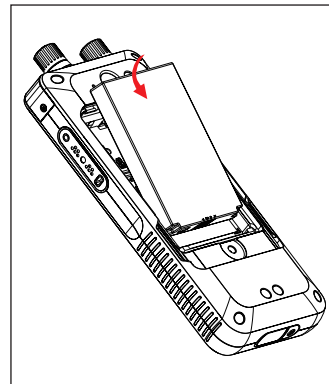

4. Open SIM card tray, insert SIM card and lock SIM card tray into the place.

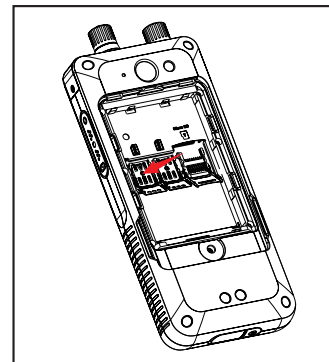

 PLEASE ENSURE THAT A VALID NANO SIM CARD IS INSERTED IN YOUR PHONE.

INSERTING THE MEMORY CARD

Insert the memory card to add extra storage space for your music, pictures, videos, and more.



MEMORY CARD IS OPTIONAL AND SOLD SEPARATELY.

1. SLIDE THE SILVER CLIP

Slide (push forward) and lift the silver clip over the designated slot located beside the SIM card slot (as shown in the figure).

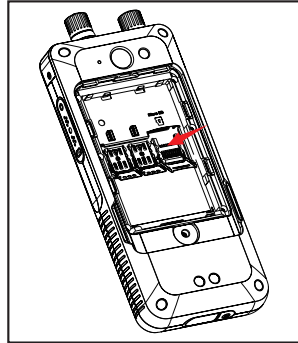

2. PLACE THE MEMORY CARD

Place the memory card in the designated slot and close the silver clip (as shown in the figure).

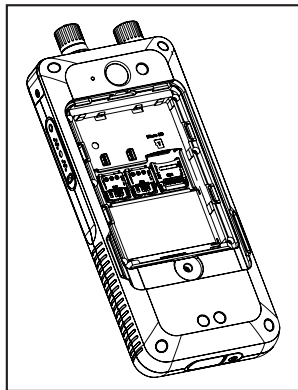

3. CLOSE THE BATTERY COVER

Use Sonim provided screwdriver and tighten the screw on the back cover.

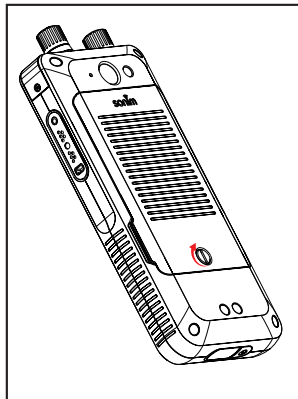

USING YOUR SONIM XP5PLUS DEVICE



- | | |
|--|--|
| <ol style="list-style-type: none"> 1. PTT Dedicated Key 2. Volume Up / Down 3. Volume Knob 4. Status Bar 5. Display 6. Dynamic Keys 7. Loud Speaker Key 8. Answer/Accept 9. Voicemail 10. Loud Speakers 11. Lock/Unlock 12. Channel Selector Knob 13. Air Pressure Sensor 14. Back/Clear 15. End/Reject/Power On/Off/Primary Navigation | <ol style="list-style-type: none"> 16. Select/Center button 17. Navigation Keys 18. Text Input Mode 19. Primary Microphone 20. Camera 21. Flash LED 22. Battery Cover 23. Battery Cover Screw 24. Charging Pins 25. SecureAudio™ Connector 26. Lanyard Connection Point 27. 2nd Microphone 28. Emergency Button 29. USB Type C |
|--|--|

SWITCHING ON THE PHONE

Press and hold Power **On/Off** key for 2 seconds. This is the RED key immediately above the 3 key on the keypad.

When the phone is switched on, it will attempt to register with the network. After successful registration, "AT&T" or "FirstNet" is displayed.



Ensure that a valid Nano SIM card is activated into your phone or your device will not properly work on the AT&T or FirstNet network.

PHONE OPERATIONS WITHOUT SIM CARD

You can perform the following operations without inserting the SIM card in your phone.

- Make an emergency call.
- View and modify all settings except data usage and mobile network related settings.
- Activate and share files through Bluetooth.
- Access the Internet using Wi-Fi connectivity.
- Access your phonebook, File explorer multimedia files, all tools and applications.
- View and modify your profile settings.

MANAGING HOME SCREEN

After you complete the phone setup, the home screen is displayed. The home screen is the beginning point to access all of the device's features. If at any point you want to immediately access the Home Screen, simply press the Power On/Off key, the key immediately above the 3 key on your keypad.

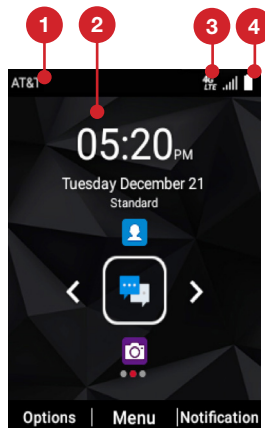

1. Notification Bar
2. Home Screen
3. Signal Strength Bar
4. Battery Indicator

KEY DESCRIPTION

The navigation keys are located below the display screen.

ICONS	DESCRIPTION
	<p>Back:</p> <p>Opens the previous screens in the working sequence until the home screen is displayed. Once the home screen is displayed, it remains there even when you press the back key.</p> <p>Back key also works as delete key for the text input field.</p>
	<p>Speaker:</p> <p>You can place the call in speaker mode and this icon is enabled only when call is on the speaker.</p> <p>For better results in a noisy environment, hold the device 15-20cm (6-8 inches) from your mouth while speaking in speaker mode.</p>































Do not cover the microphone as it may compromise the audio quality.

NOTIFICATION BAR ICONS

The icons displayed at the top of the screen provide information about the status of the device. The details such as battery charge status and data service are displayed when the phone is in standby mode. Other indicators if the features are activated such as Bluetooth connectivity status, airplane mode, alarm and call forward (only if Always Forward is enabled) and Wi-Fi connectivity are displayed.

ICONS	DESCRIPTION
	Battery level indicator
	Battery charging in progress
	No signal

ICONS	DESCRIPTION
	Signal strength
	4G LTE network connected
	Wi-Fi connected
	Wi-Fi
	Location icon
	Bluetooth
	Bluetooth connected
	RTT icon
	Call in progress
	Speaker icon
	FM Radio
	Missed call
	New SMS or MMS
	Alarm activated
	Silent mode activated
	Vibration mode activated
	Headset connected
	Missed events notification
	Hidden notifications
	Airplane mode activated
	Music is playing
	Device storage space is running out

ICONS	DESCRIPTION
	Profile status - Meeting
	Profile status - Outdoor
	Profile status - Silence
	USB
	Event Voice mail
	Signal bar with data enabled
	Mobile data disabled
	Data in and out
	Roaming
	Roaming with data enabled
	Roaming with data disabled

CAPTURING A SCREENSHOT

You can take a screenshot of the current screen and it will be stored in your phone's gallery.

To take a screenshot:

1. Ensure that the image to be captured is displayed on the current screen.
2. Press the **Power** and **Volume down** button simultaneously. The screen shot is captured and it will be stored in the gallery.

Or

3. Long press the **Power** button, then select "**Screenshot**". The screen shot is captured and stored in the gallery.

TO CHANGE THE INPUT LANGUAGE

1. To change the input language of your text messaging, press and hold the * key and select the language you would like to type in.
2. You can change the **Language** from **English** to **Spanish** or other languages and vice versa.

TEXT ENTRY OPTIONS

When entering text, you can change the text entry options by pressing the # key. The currently selected text entry option is displayed in the Status bar at the top of the screen.

The various text entry options are:

- **KT9:** Enter the text based on the KT9 dictionary. Only the first letter of the sentence is capitalized. Start by pressing the numeric keys from 2 through 9 only once for the required letter.
- **Ex 1:** To enter the word "Home", press 4-6-6-3. The word displays on the screen as you type.
- **Ex 2:** To enter the word "Hello", press 4-3-5-5-6. The word displays on the screen as you type.

If the word does not display correctly, press the right navigation key to scroll through alternative word choices.

- **EN:** Enter all the text in upper case.
- **En:** Enter the first letter of the sentence in upper case.
- **en:** Enter all the text in lower case.
- **123:** Enter the numbers.
- **Emojis:** Select the Emojis.
- **Symbols:** Enter a symbol. You can also press the * key to quickly get the full symbol list.

HOME SCREEN MENU OPTIONS

In order to see the details about any notifications, on the home screen, select the **Notification key**.

When tapping the Options key, the following options are displayed:

- Wallpaper
- Search
- Home screen shortcuts
- System settings
- Manage apps

WALLPAPER

You can set an image or a photo stored in your gallery as your home screen wallpaper or select pre-loaded wallpaper.

To change the wallpaper, from the **Home screen**, press **Options key > Wallpaper**. Select wallpaper from the pop-up.

- **Gallery:** Includes photos and screenshots taken using the phone's camera.
- **Wallpapers:** Includes images that are pre-loaded with the phone.

SEARCH

You can search for people, places, music, movies and much more. Enter the keyword in the search bar and results will be displayed. Internet access is needed for the Search feature.

HOME SCREEN SHORTCUTS

The navigation **Up**, **Center**, and **Down keys** are displayed.

For more information, refer to “Home screen shortcuts” on page 25.

SYSTEM SETTINGS

System settings refers to the following settings. For more information, refer to:

- “Network and Internet Settings” on page 14
- “Connected Devices” on page 17
- “Apps & Notifications” on page 18
- “Battery settings” on page 19

- “Display settings” on page 19
- “Sound settings” on page 20
- “Storage settings” on page 22
- “Security settings” on page 23
- “System settings” on page 25

MANAGE APPS

You can manage applications and force stop them. For more information, refer to “Apps & Notifications” on page 18.

QUICK SETTINGS

In order to see the quick settings, on the home screen, select the **Left Navigation key**.

The following settings are displayed:

- Wi-Fi
- Data
- Bluetooth
- Flashlight
- Airplane mode
- Profiles

These settings can be enabled or disabled.

MOBILE HOTSPOT

You can enable or disable Mobile hotspot settings. For more information, refer to “Hotspot and tethering” on page 15.

WI-FI

You can enable or disable Wi-Fi settings. For more information, refer to “Wi-Fi” on page 14.

DATA

You can toggle your Mobile Data settings **ON** or **OFF**. For more information, refer to “Wi-Fi Data Usage” on page 14.

BLUETOOTH

You can toggle your Bluetooth settings **ON** or **OFF**. For more information, refer to “Bluetooth” on page 17.

FLASHLIGHT

You can toggle your flashlight **ON** or **OFF**.

AIRPLANE MODE

You can enable or disable Airplane Mode. For more information, refer to “Airplane Mode” on page 15.

PROFILES

You can select the profile from the list:

- Standard
- Outdoor
- Silence
- Meeting

For more information, refer to “Sound” on page 20.

MISSED EVENTS

To view the missed events from the home screen, select the **Right navigation key**.

Missed events are missed calls or any events which were saved earlier on the device.

The missed events can be:

- Missed calls
- Calendar events
- New messages
- Alarm
- New Voicemail



NETWORK AND INTERNET SETTINGS

WI-FI

Wi-Fi is a wireless network technology that can provide internet access at distance up to 100 feet depending on the Wi-Fi router and surroundings.

You can access the internet when you connect your XP5plus to a Wi-Fi network.

To connect your phone to a Wi-Fi network:

1. From **Home** screen, select **Menu > Settings** () > **Network & Internet** ().
2. Select **Wi-Fi** () and turn **ON**.
A list of Wi-Fi access points are displayed.
3. Select your preferred network. Enter the **WEP/WPS/WPA** key (if it is a secured network) and select **Connect**. To verify the password before connecting, enable **Show password**.



It is always recommended to make your Wi-Fi network connection secure and also to connect your phone to a secure network.

ADD NETWORK

1. In **Wi-Fi** settings screen, select **Add network**.
2. Enter the following details or select **Scan QR Code**, join Wi-Fi by scanning a QR code:
 - **Network SSID**: The wireless network ID.
 - **Security**: Set the security type to None, Enhanced Open, WEP, WPA/WPA2-Personal, WPA3-Personal, WPA/WPA2/WPA3-Enterprise, WPA3-Enterprise 192-bit.

Or

- Scan QR code.
3. Enable **Advanced options** to set the Hidden network, Metered and Proxy details and IP settings.
 4. Select **Save** to save the network settings.

CONNECT TO A NETWORK

1. Select a desired network from the list after the Wi-Fi scanning is complete.
2. Enter the password and get connected to the network.

EDIT A NETWORK



1. Select connected network.
2. Press the **OK** key. You can change/update the network password and other advanced options such as **Metered, Proxy, IP settings**, etc.

FORGET A NETWORK

1. Press and hold the connected network.
2. Select **Forget network**.
The selected network gets disconnected and displayed in the Wi-Fi list.



If you desire to get connected to the same network, enter password.

WI-FI PREFERENCES



1. From **Home** screen, select **Menu > Settings** () > **Network & Internet** ().
2. In **Wi-Fi** settings screen, select **Wi-Fi preferences**.
3. The following options are displayed:
 - **Turn on Wi-Fi automatically**: Enable this option to notify you when a high-quality saved network is available, like your home network.
 - **Notify for public networks**: Enable this option to notify you when a high-quality public network is available.
 - **Advanced**: The following options are displayed:
 - **Install certificates**: You can browse a certificate for installation.
 - **Switch to mobile data automatically**: Use this option when Wi-Fi has no internet access. Data usage charges may apply.
 - **Network rating provider**: By default, this option is grayed out.
 - **Wi-Fi Direct**: This allows to connect directly from XP5plus to another devices, a PC or television.

WI-FI DATA USAGE



To monitor your data usage, adjust your data usage settings.

1. From **Home** screen, select **Menu > Settings** () > **Network & Internet** ().
2. Select **Wi-Fi** () > **Wi-Fi data usage**.
3. When Wi-Fi is enabled, it shows the data used for a particular time frame.

SAVED NETWORKS

1. From **Home** screen, select **Menu > Settings** () > **Network & internet** ().
2. To add new Wi-Fi network, select **Wi-Fi > Add network** ().
3. If your XP5plus is connected to a Wi-Fi network, you can view all the saved Wi-Fi networks in your device.
4. To view saved networks from the Wi-Fi settings screen, select **SAVED Networks**.

MOBILE NETWORK

1. From **Home** screen, select **Menu > Settings** () > **Network & Internet** ().
2. Select **Mobile Network** ().
3. Under **Mobile Network**, you have the following options:
 - **Mobile data:** Enable **Mobile data** to get connected to the internet and use mobile data services such as email, web browsing and push notifications over the cellular network.
 - **International Data Roaming:** Enable **International Data Roaming** to connect to the data services when on a different network or out of your home country.



You may need to activate this service with your carrier prior to accessing the roaming network.

- **App data usage:** **Data usage** refers to the amount of data utilized by your phone during data transfers through the internet. The data usage charges are dependent of the wireless plan provided by your service provider.
 - **Data warning & limit:** To set the data usage limit.
4. Under **Advanced Network**, the following options are displayed:
 - **Automatically select network:** Turn **ON** this option to get connected to the network automatically.
 - **Choose network:** Your network operator name is displayed.
 - **Access Point Names:** You can view the access points related to your SIM provider.

AIRPLANE MODE



When your phone is set in Airplane mode, network connectivity or mobile data connectivity is disabled, but you can access your camera, media files and other features that do not require mobile connectivity.

To activate Airplane mode:

1. From **Home** screen, select **Menu > Settings** () > **Network & Internet** ().
2. Enable **Airplane mode** ().

HOTSPOT AND TETHERING



You can use hotspot and tethering to provide internet to other devices through your mobile data connection. You can share mobile data connection via USB/mobile hotspot/Bluetooth.

1. From **Home** screen, select **Menu > Settings** () > **Network & Internet** ().
2. Select **Hotspot & tethering** ().
3. **Mobile hotspot:** When you turn **ON** mobile hotspot it uses mobile data from your plan whenever you are not connected to Wi-Fi. And also you can share your mobile data connection with other devices. You can set up the mobile hotspot details by entering the following details:
 - **Hotspot name:** Enter the **hotspot** name.
 - **Security:** Select the **security** from the drop-down list.
 - **Hotspot Password:** You have the option to set your Hotspot password, which must contain at least 8 characters.
 - **AP Band:** Select preferred band.
 - **AP channel selected:** Select preferred channel number.
 - **Timeout Settings:** Auto disables Mobile Hotspot after 10 minutes inactivity.
 - **Maximum connections:** Your XP5plus Mobile Hotspot may support up to 10 devices at one time.
 - **Allowed devices:** You can turn this feature **ON** to allow connected devices to add other devices.
 - **Connected Devices List:** This will show the list of devices currently connected to your XP5plus.
4. **USB tethering:** Tethering is enabled only when the USB is connected to the device. This will allow the XP5plus to share the internet connection via USB.
5. **Bluetooth tethering:** When you activate Bluetooth tethering, you can share your phone's internet connection with other Bluetooth paired devices.



DATA SAVER

Some applications actively use data when running in the background. Enable **Data Saver** to restrict apps from using data in the background.

VPN

1. From **Home** screen, select **Menu > Settings** () > **Network & Internet** ().
2. Select **VPN** ().
3. Select **Add**.
4. In **Edit VPN profile** screen, enter the **Name, Type** (select from the drop-down list), and the **server address**.
5. Enter **Username** and **password**.
6. Select **Save**.

PRIVATE DNS

1. From **Home** screen, select **Menu > Settings** () > **Network & Internet** ().
2. Select **Private DNS**. The following Private DNS Mode options are displayed:
 - Off
 - Automatic
 - Private DNS provider hostname

CONNECTED DEVICES

BLUETOOTH

Bluetooth is a short-range wireless communication technology used to communicate between the devices over a distance of about 30 feet.



You can perform the following tasks using Bluetooth paired devices:

- Transfer media files and contacts between connected mobile devices using Bluetooth.
- Use Bluetooth connected headphones for playing media files.
- Bluetooth connected headsets can be connected and used during telephone calls.

PAIR NEW DEVICE



You can activate Bluetooth and pair your XP5plus device with other Bluetooth devices:

A list of paired Bluetooth devices are displayed. Ensure that Bluetooth is activated on the other device too.



1. From **Home** screen, select **Menu > Settings** () > **Connected devices** () > **Connection preferences > Bluetooth > enable Bluetooth** ().
2. On the Bluetooth screen, select **Pair new device**.
3. Select **Pair new device** to pair a new device. The device will start searching nearby Bluetooth devices. **Available devices** are listed.
4. Select the desired device from the list. It will start pairing with the selected device. A confirmation message is displayed to pair the device. Select **PAIR**.

APPS & NOTIFICATIONS



APPS INFO

1. From **Home** screen, select **Menu > Settings** () > **Apps & Notifications** ().
2. Select **Apps info**. You can view recently opened apps and the list of apps installed on the device are displayed.
3. You can change the preferences for installed apps by pressing the **OK** key.
4. You can reset all preferences you set for the apps by selecting the **Reset** app.
5. All applications info will be displayed when you select **Show** system.

DEFAULT APPS

1. From **Home** screen, select **Menu > Settings** () > **Apps & Notifications** ().
2. Select **Default apps**. The list of default apps on the device are displayed.

PERMISSION MANAGER

1. From **Home** screen, select **Menu > Settings** () > **Apps & Notifications** ().
2. Select **Permission manager**.
App permissions govern what your app is allowed to do and access.

WIRELESS EMERGENCY ALERTS

From **Home** screen, select **Menu > Settings** () > **Apps & Notifications** () **Advanced > Wireless emergency alerts**



Allow alerts: Enable this option to receive wireless emergency alert notifications.

ALERTS

- **Public safety messages:** Recommended actions that can save lives or property.
- **AMBER Alerts:** Enable this option to receive the child abduction and emergency bulletins.
- **Extreme threats:** Enable this option to receive the extreme threat alerts to life and property. For example, Tsunami, Tornado, Extreme wind, Hurricane and Typhoon warnings.



- **Severe threats:** Enable this option to get the severe threat alerts to life and property. For example, Storm surge, Flash flood and Dust storm warnings.
- **State and local tests:** Receive test messages from state and local authorities.
- **Emergency alert history:** If you have any active emergency alerts, they are displayed in Alert History.
- **Alert Preferences:**
 - **Vibration:** Enable this option to set the device on vibrate while receiving the alert.
 - **Audio:** Enable this option to receive audio during the alert.
 - **Alert Reminder:** You can set the following time duration for alert reminder sound: **Once**, **Every 2 minutes**, **Every 15 minutes** and **Never**.
 - **Spanish:** Receive emergency alerts in Spanish when possible.

SPECIAL APP ACCESS

1. From **Home** screen, select **Menu > Settings** () > **Apps & Notifications** ().
2. Select **Special app access**.
The following settings are displayed:
 - ALL files access
 - Battery optimization
 - Wi-Fi control





BATTERY SETTINGS

BATTERY

1. From Home screen, select **Menu > Settings** () > **Battery** ().
2. Set the Battery saver **ON** by selecting the option given to turn on automatically.
 - **Set a Schedule:** You have options to set the battery saver:
 - No Schedule
 - Based on percentage
 - **Turn off when charged:** Battery Saver turns off when your phone is at 90%.
3. Turn on the **Battery LED** light.
4. **Battery Percentage:** Show battery percentage in status bar.
5. Turn on the **Battery Manager** to detect when apps drain battery.
6. In **Last Full Charge**, it shows when the battery is fully charged.
7. The Screen usage duration is displayed.
8. **Screen usage since full charge:** you can view the different applications usage after the battery is fully charged.
9. Battery usage data is approximate and can change based on usage.



DISPLAY SETTINGS

DISPLAY

1. From **Home** screen, select **Menu > Settings** () > **Display** ().
2. To set your phone's display settings, select one of the following options:
 - **Brightness level:** Set the brightness of the phone display. This also affects the battery power.
 - **Wallpaper:** Set the wallpaper for your home screen. You can select from one of the following wallpaper collections:
 - **Gallery** (): Includes photos and screenshots taken **using the phone's camera**.
 - **Wallpapers** (): Includes images that are pre-loaded with the phone.
3. Select **Screen timeout**. Set the screen time so that the screen brightness is turned down after specified time of phone inactivity. This setting also affects the battery power. The following are the options: 15 seconds, 30 seconds, 1 minute, 2 minutes, 5 minutes, 10 minutes and 30 minutes.
4. Select **Font size**. Set the font size of the text as displayed on the screen.

SOUND SETTINGS

SOUND

1. From **Home** screen, select **Menu > Settings** () > **Sound** ().
2. Select **Profile** and the following options are displayed:

OPTION	DESCRIPTION
1. Standard	Set to Standard and select Edit . The following options are displayed:
Sound	<ul style="list-style-type: none"> • You can set Media volume, Ring volume, Alarm volume, Notification volume, Phone ringtone, Default notification sound. • You can enable the Vibrate when ringing.
Other Sounds	You can set Screen lock sounds, Charging sounds, and
Notification	<ul style="list-style-type: none"> • If Notification LED is enabled, battery status indication is not affected. • If Flash Notification alert is enabled and the battery level is above 20%, you can use the camera flashlight for missed events. • If Flash call alert is enabled, you can use Flash camera light for incoming voice call.
2. Outdoor	Set to Outdoor and select Edit . The following options are displayed:

OPTION	DESCRIPTION
Sound	<ul style="list-style-type: none"> • You can set Media volume, Ring volume, Alarm volume, Notification volume, Phone ringtone, Default notification sound. • You can enable the Vibrate when ringing.
Other Sounds	You can set Screen lock sounds, Charging sounds, and Key Press tones .
Notification	<ul style="list-style-type: none"> • If Notification blink light is enabled, battery status indication is not affected. • If Flash Notification alert is enabled and the battery level is above 20%, you can use the camera flashlight for missed events. • If Flash call alert is enabled, you can use Flash camera light for incoming
3. Silence	Set to Silence and select Edit . The following options are displayed:
Sound	When set to Silence mode, this profile blocks all sounds and vibrations including alarms, music, videos, and games. You will be able to make phone calls.
Notification	<ul style="list-style-type: none"> • If Notification LED is enabled, battery status indication is not affected. • If Flash notification alert is enabled and the battery level is above 20%, you can use the camera flashlight for missed events. • If Flash call alert is enabled, you can use Flash camera light for incoming voice call.

OPTION	DESCRIPTION
4. Meeting	Set to Meeting and select Edit . The following options are displayed:
Sound	You can set Media volume, and Alarm volume.





Apart from default profiles, user can create customized profiles.



You can select anyone from the profiles list.

TO CREATE A NEW PROFILE

1. From **Home** screen, select **Menu > Settings** () > **Sound** () > **Profile**.
2. Select **Profiles > Create**.
3. Enter the required **profile name**.
4. Maximum length of 24 characters is allowed for the profile name and the name must be unique. After modifying the necessary sound and notification settings, save the new profile.

SOUND

- **Media Volume:** You can increase, decrease, and mute media volume.
- **Alarm volume:** You can increase, decrease or mute the alarm volume.
- **Ring volume:** You can change the ringer volume to no ringer or ringing.
- **Notification volume:** You can increase, decrease or mute the alarm volume.
- **Vibrate for calls:** Enable this option to set the device to vibrate for incoming calls.
- **Shortcut to prevent ringing:** Enable this option to prevent ringing.
- **Phone ringtone:** You can select the required ringtone from the list.
- **Default notification sound:** Set the default notification sound from the list.
- **Default alarm sound:** The tone listed here is the default alarm sound.

OTHER SOUNDS AND VIBRATIONS

- **Dial pad tones:** Enable or disable this option.
- **Screen locking sounds:** Enable or disable this option.

- **Charging sounds and vibrations:** Enable or disable this option.
- **Key press tones:** Enable or disable this option.



NOTIFICATION

- **Notification blink light:** Use this feature to enable or disable the notification blink light.
- **Flash notification alert:** If Flash notification alert is enabled and the battery level is above 20%, you can use the camera flashlight for missed events.
- **Flash call alert:** If Flash call alert is enabled, you can use Flash camera light for incoming voice call.

VOICE NOISE CANCELLATION



FENS: By default, FENS is enabled and reduces the noise cancellation.

QUICK PROFILE SWITCH

1. From **Home** screen, select **Menu> Settings** () > **Sound** () > **Profile**.
2. Select **Quick Profile Switch**.
You can use this option to quickly switch profiles via home screen shortcut.

STORAGE SETTINGS



STORAGE

1. From **Home** screen, select **Menu > Settings** () > **Storage** ().
2. On **Internal shared** storage, the list of applications are displayed with memory used for each applications:
 - Photos and videos
 - Music and audio
 - Other apps
 - Files
 - System
3. Press **Manage key > Free up space** key to free the space from the internal storage.

PRIVACY SETTINGS



PRIVACY

PERMISSION MANAGER

1. From Home screen, select **Menu > Settings** () > **Privacy** ().
2. **Permission Manager:** Apps with the following permission can access to your data:
 - Body sensors
 - Calendar
 - Call logs
 - Camera
 - Contacts
 - Files and Media
 - Location
 - Microphone
 - Phone
 - Physical activity
 - SMS
 - Additional permissions - Power Off Alarm
3. **Show Passwords:** Enable this option to display characters briefly as you type.

LOCATION SETTINGS

LOCATION

1. From **Home** screen, select **Menu > Settings** () > **Location** ().
2. Set the **Use Location** to **ON** status.
3. The **No Apps have requested location recently** option is the default setting and you are able to view recent location requests.
4. **App access to location:** Apps with this permission can access the device's location.



Wi-Fi and Bluetooth Scanning:

1. **Wi-Fi Scanning:** Enable Wi-Fi scanning to improve location by allowing system apps and services to detect Wi-Fi networks at any time.
2. **Bluetooth scanning:** Enable Bluetooth scanning to improve location by allowing system apps and services to detect Bluetooth devices at any time.

SECURITY SETTINGS

SECURITY



You can activate and protect your phone from unauthorized access by configuring the security settings.

1. From **Home** screen, select **Menu > Settings** () > **Security** ().
2. **Screen Lock:** Select Screen lock and select one of the following options to configure the phone:
 - None
 - Press and hold (*) key
 - PIN: When enabled, enter your own PIN value. When the phone is locked, unlock it using the PIN. When the phone is locked, you can answer an incoming call without unlocking the phone.
3. **Device admin apps:** Select the apps and activate the device admin apps.
 - **SonimCare:** You can activate this admin app to allow Sonim Care to control on how and when the screen locks.
4. **Encryption & credentials:**
 - **Encrypt phone:** Select **Encrypt phone** to encrypt your accounts, settings, app and their settings, media and other files.
 - **Storage type:** Displays the storage type.
 - **Trusted credentials:** You can view and verify the system and user certificates.
 - **User credentials:** You can view and modify stored credentials.
 - **Install certificate:** You can install certificate from storage.
 - **Clear credentials:** You can remove all certificates.

ACCESSIBILITY SETTINGS

ACCESSIBILITY

You can make websites and applications more accessible to people with disabilities when they are using mobile phones and other devices.

1. From **Home** screen, select **Menu > Settings** () > **Accessibility** ().

2. **TTY mode:**

Set any one of the following options:

- **TTY Off:** Disables TTY mode.
- **TTY Full:** Enables TTY mode for both incoming and outgoing calls. Set this for both hearing and voice assistance.
- **TTY HCO:** Enables TTY mode only for incoming calls. Set this for only hearing assistance.
- **TTY VCO:** Enables TTY mode only for outgoing calls. Set this for only voice assistance.

3. **Downloaded Apps: Talkback:**

- **Use Talkback:** When Talkback is enabled, it helps vision-impaired users interact with their devices. It uses spoken word, vibration and other audible feedback to let you know what is on your screen.

4. **Screen Readers:** The following option is displayed under **Screen readers**.

Text-to-speech output:

- **Preferred engine:** The Nuance talkback engine is set as default.
- **Language:** You can select the desired language to adjust the spoken language. System language is set as default language.
- **Speech rate:** You can move the speech rate using the slider to adjust how faster or slower the text will be spoken.
- **Pitch:** You can move the pitch value using the slider to adjust how high or low the text will be spoken. You can demonstrate a speech synthesis.

5. **RTT (Real Time Text) Visibility:** RTT allows you to use the keypad to type messages back and forth during a call. There are two ways you can allow RTT messages:

- Only during a call
- During and when placing/receiving a call

6. **Display:**

- **Font size:** You can adjust the font size to meet your visual needs.
- **Voice Command:** Enables long press speaker key to allow voice command.

7. **Interaction Control:**

- **Speaker:** During a call, switch audio among earpiece, speaker and accessory if attached.
- **Vibrate & haptic strength:** You can enable/disable **Ring vibration** and **Notification vibration**.



8. **Audio & On-screen text:**

- **Mono Audio:** Enable **Mono audio** to combine the channels when playing audio.
- **Caption preferences:** When **Captions** is set to **ON**, you can set the following options:
 - Show captions
 - Caption size and style
 - Language

SYSTEM SETTINGS



HOME SCREEN SHORTCUTS

On your XP5plus you have the ability to program the 3 **Navigation** keys to quickly access & launch the selected apps on your device.

1. From **Home** screen, select **Menu > Settings** () > **System** ().
2. Select **Home screen shortcuts** ().
3. Select the **Up Navigation** key and select the app that you would like to be launched when you press the **Up Navigation** key.
4. Select the **Center Navigation** key and select the app that you would like to be launched when you press the **Center Navigation** key.
5. Select the **Down Navigation** key and select the app that you would like to be launched when you press the **Down Navigation** key.



PROGRAMMABLE KEYS

You can assign any application to the programmable key.

1. From Home screen, select **Menu > Settings** () > **System > Programmable Keys** ().
2. Select **Programmable key** (). The following options are displayed:
 - Knobs
 - Volume Up Key
 - Volume Down Key
 - Select PTT Key app
 - Select Alarm Key app
 - Select Press and Hold timer to engage PTT

LANGUAGES & INPUT

You can set the phone's language to any of the languages displayed in the language list.



1. From **Home** screen, select **Menu > Settings** () > **System** ().
2. Select **Languages & input** ().
3. Go to **Languages** and select any language from the list as your preferred language.
The following languages can be set as a preferred language:
 - English
 - Spanish

All the menu items and user feedback messages will be displayed in the set language.



4. Select **On-screen keyboard > 12key-keyboard**.
 - **Language:** You can set the input language to either English, Spanish, Canadian French, Korean and Simplified Chinese.
 - **System keyboard language:** You can switch the language to English or Spanish.
 - **Personal dictionary:** You can add the desired custom words to the dictionary.
 - **Auto-capitalization:** The first letter of the new sentence is automatically capitalized.
 - **Double-space period:** If this option is enabled, when you press the space key twice at the end of a word, a period will be inserted.
 - **Prediction:** Predicts a new word based on the previous word entered.
 - **Long press * to switch language:** This option enables to switch language. You can change the **Language** from **English** to **Spanish** or other languages and vice versa.
5. Select **Text-to-speech output**. You can set and reset the **Speech Rate** and **Speech Pitch**.

DATE & TIME



You can set and display the date and time on the phone. You can also select the display format.

1. From **Home** screen, select **Menu > Settings** () > **System** ().
2. Select **Date & time** ().
3. Select the following options to configure phone:
 - Enable **Use network-provided time** to synchronize the date and time with the network provided time.
 - Enable **Use network-provided time zone** to synchronize the time zone with the network provided time.
 - To set the date manually, select **Date**. Scroll and select the date, month and year. Select **OK**.
 - To set the time manually, select **Time**. Scroll and select the hour and minute. Select **OK**.
 - To set the time zone, select **Time zone**. Select Region and select your time zone.
 - **Time Format:**
 - Enable **Use locale default to set default time**.
 - Enable **Use 24-hour format** to set the clock to 24-hour format. By default, the phone is set to **12-hour format**.



SYSTEM UPDATE

1. From **Home** screen, select **Menu > Settings** () > **System Updates** ().
2. Select **Check for Updates**. If there are any updates required, the update process begins. If there are no updates required, a message will be displayed showing **No update is available for your device at this time**.

RESET OPTIONS

1. From **Home** screen, select **Menu > Settings** () > **System** ().
2. Select **Reset options** ().
3. You can reset the following settings:
 - Reset Wi-Fi, mobile & Bluetooth
 - Reset app preferences
 - Erase all data (factory reset): **Important Note:** All your personal data will be erased.

ABOUT PHONE

From **Home** screen, select **Menu > Settings** () > **About phone** (). The following information is displayed:

- Device name
- Phone Number
- Emergency information
- Legal information
- SIM Status
- Model & Hardware
- IMEI
- Android version
- IP address
- Wi-Fi MAC address
- Device Wi-Fi MAC address
- Build number

MANAGING CONTACTS

You can use the phonebook to maintain the contact information of your contacts. This feature enables you to add, dial phone numbers and send SMS and MMS messages.

To access the contacts, from **Home** screen, select **Contacts** (). The contacts saved in the phonebook are displayed.

ADDING CONTACT FOR THE FIRST TIME

After inserting the SIM when you switch on the XP5plus for the first time and there are no contacts listed in the device or SIM, you have two options:

1. Press **Add** from **CDK** (Center dynamic key), enter all the details and then press **Save** from CDK to save the contact. You can also enter a number using dialpad and select **Add** to contact and then **Create new contact** to add a new contact. Enter the contact details and press **Save** to save the contact.
2. **Import contacts:** Select **Import/export** to import contacts from .vcf file or from SIM card.

VIEWING CONTACT DETAILS

1. From **Home** screen, select **Menu > Contacts** ().
2. Scroll to the desired contact and select the contact to view the contact details.

SENDING A MESSAGE FROM CONTACTS

You can send SMS and MMS messages to your contacts.

1. From **Home** screen, select **Menu > Contacts** ().
2. Scroll to the desired contact and open it.
3. Select **Option key > Send message**.
4. Enter the message and select **Option key > Attach photos/videos** to attach the photos and videos.
5. Select **Send**.



If you attach a media file or a contact to your SMS message it is converted to an MMS message automatically.

DIALING A NUMBER FROM CONTACTS

1. From **Home** screen, select **Menu > Contacts** ().
2. Scroll to the desired contact and select the contact to view the details.
3. Select the **number** and press the **Center** key to initiate the call.

Or

4. Select the desired contact from the list and press the green button on the phone to initiate the call.

EDITING THE CONTACT DETAILS

1. From **Home** screen, select **Contacts** ().
2. Scroll to the desired contact and select the contact to view the details.
3. Select **Edit**.
4. Edit the desired details. Select **Save** to save the details.

On the **Contacts** screen, select **Options key** to view the menu options. Following are the menu options:

IMPORT/EXPORT

IMPORT CONTACTS FROM CLOUD

You can sync your cloud contacts, eg., Google, Exchange active sync and Outlook contacts from server to device:

1. From **Home** screen, select **Menu > Contacts** ().
2. Select **Option key > Import/export > Import from cloud**. You can select either account to sync contacts from the selected account server.
3. After finishing the setup process, contacts will be downloaded to your device. Any changes made in the device will be synced back to the server.
4. You can change the default contacts storage from the Phone to any account via **Settings > Default contact storage**, new contacts created afterwards will be backed up to the default storage account automatically.
5. You can delete the account via **Settings > Delete cloud account**.
6. You can also move the phone contacts to cloud via **Settings > Move contacts to cloud account**.

IMPORT FROM .VCF FILE

1. From **Home** screen, select **Menu > Contacts** ().
2. Select **Option key > Import/export**.
3. Select **Import from .vcf file**.
4. Select **Done**.
The contact is imported to the list.

IMPORT FROM SIM CARD

1. From **Home screen**, select **Menu > Contacts** ().
2. Select **Option key > Import/export**.
3. Select **Import from SIM card**.
4. The list of contacts stored in your SIM card are displayed.
5. Select the contact to be moved to the phone.
6. Select **Done**.
7. A confirmation message is displayed. Select **OK** to confirm. The contact is imported to the phone address.

EXPORT TO SIM CARD

1. From **Home screen**, select **Menu > Contacts** ().
 2. Select **Option key > Import/export**.
 3. Select **Export to SIM card**.
 4. Select the contact to be exported from Phone to SIM card.
 5. Select **Done key**.
- Selected contacts will be exported to the SIM card.

EXPORT TO .VCF FILE

1. From **Home screen**, select **Menu > Contacts** ().
 2. Select **Option key > Import/export**.
 3. Select **Export to .vcf file**.
 4. Press **Center key** to select the contact to be exported.
 5. Select **Done key**.
- A message is displayed to select the source to save the .vcf file.

SHARE ALL CONTACTS

You can send contact information in following 3 ways:

1. From **Home screen**, select **Menu > Contacts** ().
2. Select **Option key > Import/export > Share all contacts**. You can use one of the following options to share the desired contact from **Share contact via**:
 - **Bluetooth**: Send the contact details to a Bluetooth device paired with your phone. Select the Bluetooth device to share the contact.
 - **Messaging**: Send the contact details as a multimedia message to any mobile phone.

BLOCKED NUMBERS

You cannot receive either a call or a text message from a blocked number.

SELECT

You can select the required contacts by checking the boxes next to the contact.

SETTINGS

You can set the sort list to view the contacts and also the first or last name of the contact to be displayed first.

1. From **Home screen**, select **Menu > Contacts** ().
2. Select **Options key > Settings**. Set the following options:
 - **Sort by**: Sort the contact names by first name or last name.
 - **Name format**: Set the contact display name to first name or last name.

MANAGING CONTACT SETTINGS

You can edit and modify ringtone and call receiving settings for individual contacts.

1. From **Home screen**, select **Menu > Contacts** ().
2. Scroll to the desired contact and select the contact to view the contact details.
3. Select **Options key** and select one of the following:
 - **Set Ringtone** to set a specific ringtone for that contact.
 - Check the option **All calls to voicemail** to forward all incoming calls from that contact to your voicemail box.

DELETING A CONTACT

1. From **Home screen**, select **Menu > Contacts** ().
2. Scroll to the desired contact and select the contact to view the contact details.
3. Select **Options key > Press Delete key**. The contact is deleted after the confirmation.

MANAGING CALL SETTINGS

MAKING A CALL

1. From **Home** screen, select **Menu > Phone** (📞).
The phone screen with last dialed number, missed calls and received calls are displayed.

DIALING A NUMBER VIA CONTACT

1. From **Home** screen, select **Menu > Contacts** (👤).
2. Scroll to the contact and select the contact. The contact details are displayed.
3. Select the desired phone number to call the contact.

ADDING A CONTACT FROM HOME SCREEN

1. From **Home** screen, enter the desired number to be dialed.
 2. Select **Add to contact** (👤).
 3. Select **Create new contact** (👤).
 4. In the **Add new contact** screen, add the name and other details for the contact.
 5. Select **Save**.
- The contact is saved.

VIEWING CALL HISTORY

1. From **Home** screen, select **Menu > Phone** (📞).
2. The **Recent calls** screen displayed with recently called, received and missed calls.

DELETING CALL HISTORY

1. From **Home** screen, select **Menu > Phone** (📞).
2. On the **Recent calls** screen, select **Option key > Delete selected call log**.
3. A confirmation message is displayed to delete the selected call log. Select **Delete** to delete the call log. The selected call log is deleted.

SPEED DIAL SETTINGS

With the Speed dial option, the user can assign a contact to each key present in the keypad (2 to 9). User needs to press the keypad to initiate the call to the assigned contact.

To set the speed dial:

1. From **Home** screen, select **Menu > Phone** (📞).
2. On **Recent calls** screen, select **Option key > Speed dial settings**.
3. Long press key 1 to initiate a call to the voicemail.
4. Assign a contact for each key present in the keypad (2 to 9).
5. Long press a particular digit (2-9) to initiate a call to the assigned contact.

CALL SETTINGS

DISPLAY OPTIONS

You can display contacts using the following options:

- Sort by
 - First name
 - Last name
- Name format
 - First name first
 - Last name first

SOUNDS AND VIBRATION

You can change the incoming call ringtone, enable vibrate when ringing and enable audible press tone. To view and modify call settings:

1. From **Home** screen, select **Menu > Phone** (📞).
2. On **Recent calls** screen, select **Settings**. For more information, refer to “Sound settings” on page 20.

QUICK RESPONSES

When you are not able to answer an incoming call, you can send a quick response to the caller. To view and edit quick responses, select **Call settings > Quick responses**. Select the specific response message to edit. Edit the message and select **OK**.

CALL SETTINGS

1. **Calling accounts:**
 - **Make & Receive Calls:** Vibrating for outgoing call accepted - Turn on to enable vibrating mode for outgoing call accepted.
 - **SIP Accounts:**
To add a SIP account and configure your incoming and outgoing preferences:
2. Select **Calls > Calling account > SIP settings and SIP accounts**.
3. Select **Option key > Add account** to configure a new SIP account.
4. Enter the following details and select **Option key**

> **Save** to save the account:

- **Username:** Username to login to SIP account.
- **Password:** Password to login to SIP account.
- **Server:** SIP server details.
- **Optional Settings:** Select to view/modify or hide optional details such as Authentication username, Display name, Outbound proxy address, Port number, Transport type and Send keep-alive.
- **Use SIP calling:** Select **Calling accounts > Use SIP calling**. A dialog is open with the following options:
 - **For all calls:** If this option is selected and when the phone is connected to Wi-Fi network or mobile Internet, each dialed call becomes an Internet call.
 - **Only for SIP calls:** If this option is selected, only SIP call can be dialed.
- **Receive incoming calls:** Enable Receive incoming calls to answer incoming Internet calls.

5. Speaker boost: During a call, when the speaker is active, you can use the Speaker Boost function. To activate the speaker boost function, press the navigation down key during a voice call. The speaker volume will be extra loud when the speaker boost is activated. If you disable this setting, you cannot use the speaker boost function.

6. Fixed Dialing Numbers:

- **Enable FDN:** Fixed Dialing Numbers are enabled.
- **Change PIN2:** Change the PIN for FDN access.
- **FDN List:** Manage phone number list.

7. Call forwarding:

You can forward your incoming calls to a number in the contacts or a new number, provided your network operator supports this service.

Select one of the following call forward options:

SETTINGS	DESCRIPTION
Always forward	Forward all incoming calls to a pre-designated number.
When busy	Forward calls when your phone is busy.
When unanswered	Forward calls when you do not answer incoming calls.
When unreachable	Forward calls when your phone is switched off or is out of coverage area.

8. Call barring

SETTINGS	DESCRIPTION
Outgoing call barring	Outgoing calls are barred: Outgoing call, International call, International roaming call
Incoming call barring	You can select either All calls or Roaming calls.
Cancel all call barring	You can cancel the call barring option for all the calls.
Change password	You can change the password.

9. Additional settings:

- **Caller ID:** When SIM card is inserted, this option is enabled. This feature is used to display caller details (MSISDN or contact name) to the user. If there is no network connection, the number is displayed as a private number.
- **Call waiting:** When call waiting is enabled and the phone is already engaged in an active mobile call, the incoming number is displayed when you receive a call. To activate call waiting in the Call settings screen, enable **Call waiting**.

BLOCKED NUMBERS

You will not receive calls or messages from blocked numbers.

VOICEMAIL

- **Notifications:** Turn **On** to receive voicemail messages notifications.
- **Advanced Settings:** You can see **service** provider and **setup** the voicemail number.

ACCESSIBILITY

- **Hearing aids:** Turn **On** Hearing aids to set your device hearing aid compatible.

SENDING MESSAGES

SMS and MMS are convenient and inexpensive means of communication. You can send a text message to other people via SMS service. MMS allows you to send messages by including multimedia content such as pictures, audio files, video files, and so on.

You can use the Messaging in your phone to send an SMS and MMS message to other mobile phones or any other equipment that can receive SMS and MMS.



The MMS feature is available only if you subscribe to it from your network operator.

To access the message function, from **Home** screen, select **Messaging**.

SENDING SMS/MMS MESSAGE

You can send SMS and MMS messages to contacts in your phonebook and to new numbers that are not present in the phonebook.

1. To create a SMS message, from the **Home** screen, select **Messaging** ().
2. Select **New**.
3. Enter the contact name or the phone number in the **To** field. If you enter letters, all of the contact names starting with that letter and containing that letter will be displayed in a list. Keep typing to further reduce the list or scroll down to select the appropriate contact.
4. Type the message.

When you add an attachment, the message is automatically converted to a multimedia message. MMS charges will apply, based on the operator. You can add any multimedia attachment up to the size of ≤ 2 MB.

On a new message screen, select the **Options key** and the following options are displayed:

- **Attach photos/videos:** Select a photo or video from the Gallery.
- **Attach others:** You can select any of the following attachments to send a message.
- **Discard:** Select **Discard** to delete the message. The message thread is deleted after confirmation.

ATTACHMENT TYPE	DESCRIPTION
Audio	Attach an audio file from the phone memory.
Record audio	Record a new audio using the sound recorder and attach.
vCard	Attach a contact available in the phone.
vCalendar	Attach a calendar event.

- **Insert from templates:** You can insert an attachment from the template.
- **Insert contact:** You can insert a contact from the phonebook.

SEARCH

To search a particular message, on a messaging window, select **Options key > Search**. Enter the key word to search a particular message.

WIRELESS EMERGENCY ALERTS

You will receive active alerts and emergency alerts from the service provider.

MESSAGE SETTINGS

1. From **Home** screen, select **Messaging** ().
2. Select **Option key > Settings**. The following settings are displayed:

SETTINGS	DESCRIPTION
DISPLAY	
Group notification message	Enable this notification message to auto combine the notification into one group.
STORAGE	
Delete old messages	Delete old messages automatically when the storage limit is reached.
Text message limit	Set the maximum number of SMS messages to be stored. By default, 1000 messages can be stored.

SETTINGS	DESCRIPTION
Multimedia message limit	Set the maximum number of MMS messages to be stored. By default, 1000 messages can be stored.
Memory status	Shows the memory used for SMS, MMS and the total memory used.
ADVANCED SETTINGS	
Text (SMS) messages settings	
Message template	Edit the quick message template.
SMS signature	Enable this option to edit SMS signature to do SMS signature.
Manage SIM card messages	Manages the messages in the SIM card located under Text Messages .
Enable WAP PUSH Service	Enable to receive service message.
Multimedia (MMS) messages settings	
Group messaging	Enable and use MMS to send a single message when there are multiple recipients.
Delivery reports	Enable this option to request a delivery receipt for each message you send.
Read reports	Enable this option to request a read receipt for each message you send.
Auto-retrieve	Enable this option to retrieve the messages automatically.
Roaming auto-retrieve	Enable this option to automatically retrieve messages while roaming.

DELETING MESSAGES

To delete the messages,

1. From **Home** screen, select **Messaging** ().
2. Select the message and press **Option key** > **Delete thread key**.
3. A confirmation message is displayed. Select **Delete** to delete the selected message.
4. To delete an individual conversation, select the conversation to be deleted and select **Delete** option and confirm the choice.

SONIMWARE™ SCOUT

SonimWare™ SCOUT is a solution that allows the user to register with Sonim and use a number of key enterprise features on the XP5plus.

A SonimWare™ CLOUD account is required to fully utilize SCOUT capabilities. For more information, visit <http://www.sonimcloud.com>.

To access SonimWare™ SCOUT,

- From **Home** screen, select **Menu > Sonim Scout** ().

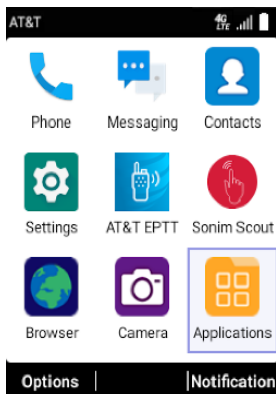

SETUP

Setup tab consists of the following features:

- Sonim Setup Wizard
- SafeGuard
- App Updater
- Kiosk Mode
- MDM Helper

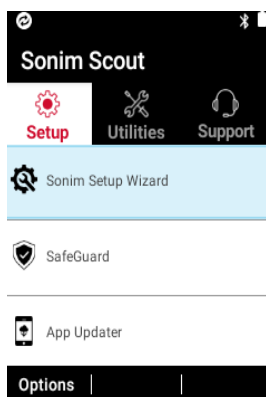

UTILITIES

Utilities tab consists of the following features:

- Contact Transfer
- Sonim BLE Connect
- Call Screening
- Stealth Mode
- Device Settings

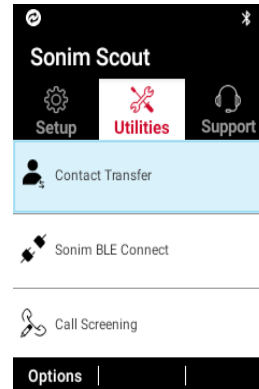

SUPPORT

Support tab consists of the following features:

- Chat
- Sonim Care
- Warranty Registration
- Device Information
- SCOUT Information
- Support Contact
- Remote Support
- Remote Log Capture

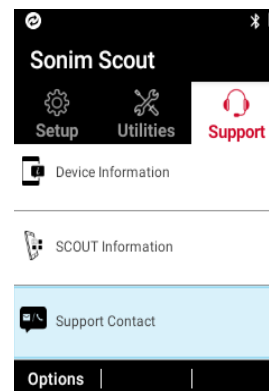

BROWSER

BROWSER

1. From Home screen, select **Menu > Browser** ().
2. Enter the URL to search for the required information or any website.

CAMERA

CAMERA

The Sonim XP5plus has a rear camera with 8MP fixed focus for taking pictures and videos. The pictures and videos are saved in the Gallery.

1. From Home screen, select **Menu > Camera** ().
2. Select Camera mode to set the following modes:
 - **Photo:** To shoot a picture in normal mode, press center key to capture the picture. Use **Left** and **Right** navigation keys for **Zoom in** and **Zoom out**.
 - **Video:** Press **Center key** to start/stop a video recording. You cannot pause the recording in the middle.
3. Select **Options key** to view or change camera settings.

CAMERA OPTIONS

Flash – Activate or deactivate the flash	Auto On Off
Timer (Secs) – Select the length of the delay before the camera takes a photo	Off 5, 10 or 15 seconds
Exposure – Control the amount of light in a photo	0 -1,-2, +1, +2
White Balance – Adjust white balance to change the color temperature in a photo	Auto Daylight Cloudy Fluorescent Incandescent
Photo Quality – Adjust photo compression level	Normal Fine Super Fine
Picture size – Adjust photo resolution	8MP, 5MP, 3MP, VGA

Face Detection – Concentrate the autofocus area on a persons face to ensure the primary subject is in focus within the photo	On/Off
Save Location – Include geolocation data with a photo	On/Off
Embed Time and Location – Display time and geolocation data on a photo	On/Off
Anti Banding – Prevent appearance of vertical or horizontal lines (banding) on photos with oscillating light sources.	Off, 50Hz, 60Hz, Auto
Shutter Sound – Enable or disable a shutter sound when taking photos	On/Off
Restore Defaults	Return device to original factory settings

GALLERY

GALLERY



The pictures, videos, and screenshots are captured from the camera are stored in the Gallery and can be viewed later.

1. From **Home screen**, select **Menu>Applications>Gallery** (). You can view the photo album, screenshots, and the individual pictures.
2. From **Gallery**, you can switch to Camera to capture pictures or videos. Select **Option key** to change the Camera or Video settings such as **Flash, Timer, Exposure** and **White Balance**.
3. Select the picture and select the **Options key** the following options are displayed:
 - **Delete:** Select this option to delete a picture.
 - **Slideshow:** Select desired photo to set it as slideshow.
 - **Details:** You can view the details such as **User comment, Flash, Orientation** etc.
 - **Rotate:** Use this option to rotate picture.
 - **Set picture as:** Select the desired photo to set it as contacts photo or wallpaper.
4. Select **Share** to share the captured images via **Messaging** or **Bluetooth**.

APPLICATIONS

DOWNLOADS



Use the **Downloads** screen to view, open, or delete the downloaded files.

1. From **Home** screen, select **Menu > Applications** ()
2. Select **Downloads** ()
3. Select **Options > Select** to select the downloaded file to be opened, viewed or deleted.

BACKUP AND RESTORE

If you need to replace your device you can backup your data to an SD card before completing a factory reset to reset your device so no one can access any data from your old device and then restore your data from the SD card where you previously backed up.

To back up your data:



1. From **Home** screen, select **Menu > Applications** ()
2. Select **Backup and Restore** ()
3. Select **Backup**.
All your contacts, Calendar, SMS and MMS data will be backed up and media content like photos, audio and videos are moved to an SD card.
A warning message is displayed that Backup may take several minutes. Please do not perform other operations during this time.
4. Select **OK** to start the backup.
5. Select **Restore**.
The contacts, Calendar, SMS and MMS will be restored.



Without an SD card, the device will not be able to be successfully backed up.

VOICE COMMANDS



The XP5plus device includes a voice recognition system for basic commands and voice dialing.

1. From **Home** screen, select **Menu > Applications** ()
2. Select **Voice Commands** ()
3. You can give a command by speaking over the phone using your voice. You can perform the voice actions like calling any of the contacts from

the phone book, get the direction to a particular destination and create reminders, etc.



CLOCK

You can view the current time of various major cities across the country and world by using the Clock feature.

1. From **Home** screen, select **Menu > Applications** ()
2. Select **Clock** ()
3. Select **World clock icon** () located on the top of the screen. To add a city, select **Add key**. Select the check boxes next to the cities to add them to the **Clock**.
Added cities are listed in alphabetical order.
 - The local time in the home city is displayed in the upper half of the screen.
 - To set the home city, select the desired city from the list. It will be added to the selected cities list. The selected city is set as the home city.

ALARM

You can set an alarm for a particular time.

1. From Home screen, select **Menu > Applications** ()
2. Select **Clock** ()
3. Select **Alarm activation icon** () on the top of the screen.
4. Select **Option key > Add** to add a new alarm.
5. To set a recurring alarm, select **Option key > Edit**.

You can choose and set the following options:

- **Time:** You can set the required time.
 - **Repeat:** You can select the days in a week to repeat the alarm.
 - **Alarm Ringtone:** Select the alarm ringtone.
 - **Label:** You can name the alarm.
 - **Vibrate:** You can enable the device to vibrate when the alarm is set.
6. Select any of the ringtones from the Default alarm tone sound present and select **OK**.
 7. Select **Option key > Save** to save the changes.

CALCULATOR

The default calculator in this phone is designed to perform simple mathematical calculations and the advanced panel for scientific calculations.

1. From **Home** screen, select **Menu > Applications**





() > **Calculator** ().

- To enter the numbers, select the numeric keys.
 - To use mathematical operators, select the respective operation key on the keypad.
 - Select = for the final result.
2. Select **Advanced panel** for scientific calculations.
 3. You can toggle between **Basic** panel and **Advanced** panel.

SOUND RECORDER

You can record voice memos using the sound recorder.

To access the sound recorder:

- From **Home** screen, select **Menu > Applications** () > **Sound Recorder** ().
- To record an audio file, select **Record** ().
- To stop the recording, select **Stop** ().
- To pause the recording, select **Pause** ().
- To save the voice memo, press left arrow key and select **Save**.
- To exit without saving, press left arrow key and select **Discard**.
- To play the recorded file instantly, press right arrow key and select the file to be played. Press the **center** key to play the voice memo.
- **Rename:** Rename the existing file.
- **Share:** You can share the recording via **Bluetooth** or **Messaging**.
- **Delete:** Deletes the selected item.
- **Select:** Select a particular file.
- **Exit:** Exits the Sound Recorder.

FILE EXPLORER

You can view/edit/delete/share the files stored in the phone through **File Explorer** ().

To view the files, select **Menu > Applications** () > **File Explorer** ().

Select any folder and press **Options key** to view the following options:

- **Recent:** Displays the recent files captured or stored.
- **Share:** Share the file or folder via Messaging/Bluetooth.
- **Copy to:** Copy the contents of the folder.
- **Properties:** View the properties of the folder.
- **Select:** Select a particular folder.
- **Exit:** You can select **Exit** option for exiting from **File Explorer**.
- **Downloads:** Displays the different folder under

Downloads.



- **Share:** Share the file or folder via Messaging/Bluetooth.
- **Delete:** Delete the existing folder.
- **Copy to:** Copy the contents of the folder.
- **Move to:** Move the contents of folder.
- **Rename:** Rename the existing folder.
- **Properties:** View the properties of the folder.
- **Select:** Select a particular folder.
- **Sort by:** You can sort the folder using **Sort** option. Sorting options are: **By Name**, **By Date Modified** and **By Size**.
- **New folder:** You can create a new folder.
- **Exit:** You can select **Exit** option for exiting from File Explorer.
- **XP5900:** Displays the different folder in the device drive.
 - **Search:** Search for the file and folder.
 - **Delete:** Delete the existing folder.
 - **Copy to:** Copy the contents of the folder.
 - **Move to:** Move the contents of folder.
 - **Rename:** Rename the existing folder.
 - **Properties:** View the properties of the folder.
 - **Select:** Select a particular folder.
 - **Sort by:** You can sort the folder using **Sort** option.
 - **Sorting options are: By Name, By Date Modified** and **By Size**.
 - **New folder:** You can create a new folder.
 - **Exit:** You can select **Exit** option for exiting from File Explorer.



If SD card is inserted, all the files in the SD card can be view/edit/delete/share from the File Explorer.

FM RADIO

You can listen to the radio through FM radio. A wired headset must be connected to enable FM radio.

1. To listen to the radio, select **Menu > Applications** () > **FM Radio** ().
2. A pop-up message is displayed: **Connect Headset**. Connect a wired Headset in the allotted slot to enable FM Radio. **FM radio** icon is displayed on the **Notification** bar.
3. Select **Options > Auto Scan** to scan all the stations. Available channels are displayed.
4. Select **Options > Settings** and the following options are displayed:
 - Regional Band
 - Audio Output Mode
 - Alternate Frequency
 - Revert to Factory Defaults

MUSIC

You can play music files and voice memos stored in your phone using the music application.

From **Home** screen, select **Menu > Applications** () > **Music** ().

- Select **Artists** to view the music files sorted based on the artists.
- Select **Albums** to view the music files sorted based on the albums.
- Select **Songs** to view the complete list of songs stored in your phone.
- Select **Playlists** to access the default playlists in the music folder.
 - Select **Recently added** playlist to view the music files that are recently added to the music folder.
 - Select **My recordings** playlist to access all your voice memo files.

CALENDAR

The Calendar helps you to set appointments, schedule reminders and alerts and repeat them if required. You can also view your saved tasks on a daily or weekly basis.

To access calendar:

1. From **Home** screen, select **Menu > Calendar** ().
2. To change the calendar view, choose **Month** or **Agenda** from **Options** menu.
3. Select **Options key** to view the list of the following available options:
 - **Today:** Access current date events.
 - **New event:** New event can be added on selecting this option.
 - **Agenda:** Select each agenda and to view the event details.
 - **Search:** You can search for a particular event.
 - **Delete Events:** Select the **event > Option key > Delete** to delete the selected event. Select **Select all** to delete all the events.

When you have an event the **Delete event** option is enabled.



- **Settings:**
 - Displays the **General settings** of the calendar.
 - Displays the **Build version** in **About Calendar**.

SIM TOOLKIT

SIM Toolkit is commonly known as STK, which enables the SIM to initiate actions which can be used for various value added services.



It displays the Operator specific services.

To access the SIM Toolkit,

1. From **Home** screen, select **Menu > Applications** () > **SIM Toolkit** ().
2. It shows **My number** which is the SIM card's MSISDN. The number includes a country code and National Destination Code which identifies the subscriber's operator.
3. It also displays the SIM provider and the respective services details.

NOTE

You can create notes using Note app.

1. From **Home** screen, select **Menu > Applications** () > **Note** ().
2. Press **New** to create new Note.

KNOB VERSION OPTIONS

The following features are available ONLY on the XP5plus WITH knobs.

From **Home** screen, select **Options > System Settings > Sounds >** scroll to **Advanced** and select **Knobs**.

- Volume Level Announcement
 - Set to OFF by default
 - Change to ON to hear voice alert when adjusting volume using the knob.
- Volume Control Knob
 - The volume control knob will control volume levels based on the setting chosen.

All active volumes is set by default

- Other options to select include:
 - **Call & PTT volumes**
 - manages volumes within voice & PTT calls
 - **Media volume**
 - manages media volume levels
 - **Ring volume**
 - manages ring tone volume levels

- **Notification volume**
 - manages notification volume levels
- **Alarm volume**
 - manages alarm volume levels
- **No function**
 - If No function is selected, the Volume Level Knob is disabled.

PROGRAMMABLE KEYS - Additional Options

From Home screen, select **Options > System Settings > System > Programmable Keys**

On the knob version of the XP5plus, you gain two additional programmable keys allowing you to further personalize your device.

Volume UP key

- default is set to increase Volume Up

Volume DOWN key

- default is set to decrease Volume Down

To program either of these keys to another function, simply click on the respective option and select from the list of available applications.

Your Sonim XP5plus allows you to the ability to program six (6) various buttons/settings, and these are found in the Programmable Keys menu:

Knobs (please see section to the left here)

- **Volume Up Key**
- **Volume Down Key**
- **Select PTT Key app**
- **Select ALARM Key app**
- **Timer to engage PTT Key**

With this setting you can set how long it takes the PTT button to activate when pressed. Options are:

- Off
- 0.1 second
- 0.25 second
- 0.50 second
- 1.00 second
- 1.25 seconds
- 1.50 seconds
- 1.75 seconds
- 2.00 seconds
- 2.25 seconds
- 2.50 seconds
- 2.75 seconds
- 3.00 seconds

CHANNEL SELECT KNOB

To control the functionality of the Channel Select Knob, you have three settings:

1. No function

This will disable to Channel Select Knob from functioning

2. Phone Always

The channel select knob works always

3. Accessory when connected (default)

The Sonim XP5plus will recognize when an accessory is plugged in. When this setting is chosen and no accessory is detected, it will defer to the phone.

SAFETY AND REGULATORY INFORMATION

ENVIRONMENT WARNING

DISPOSAL OF OLD ELECTRICAL AND ELECTRONIC EQUIPMENT



The symbol of the crossed-out wheeled bin indicates that this product, and any enhancements marked with this symbol, cannot be disposed as unsorted waste but must be taken to separate collection at their end-of-life.

DISPOSAL OF BATTERY



Please check local regulations for disposal of batteries. The battery should never be placed in municipal waste. Use a battery disposal facility if available.

The device is designed with including but not limited to the following specifications for the environmental conditions range:

- Specification of the Pollution Degree: "2"
- Specification of the Overvoltage Category: I
- Specification for maximum use altitude: not more than 5000m above sea level.
- The product does not use recycled plastics and bio-based plastics. (The content of recycled plastic and bio-based plastic is 0%)
- Does not contain textiles and leather
- Expanded polystyrene material is not used on product packaging

SAFETY WARNING

Please read and understand the following safety guidelines before you use the phone. These guidelines provide details to enable you to operate your phone safely and conform to any legal requirements regarding the use of cellular phones.



Do not use the phone at a refueling point. Observe restrictions when using radio equipment at fuel depots, chemical plants or where blasting operations are in progress.



Electrical interference may obstruct the use of your phone. Observe restrictions in hospitals and near medical equipment.



Switch off your cellular phone when in an aircraft. Wireless phones can cause interference or danger to an aircraft. In an aircraft, the phone can be used in alarm mode.



Do not expose the device to high temperatures (in excess of 55°C /131°F).



Adhere to road safety laws. Do not hold/use a phone while you are driving; find a safe place to stop first. Use hands-free microphone while you are driving.



Avoid using the phone in close proximity to personal medical devices, such as pacemakers and hearing aids.



Use only Sonim XP5900 approved charging equipment to charge your phone and avoid damage to your phone.



Ensure that only qualified personnel install or repair your phone.



The Sonim XP5900 device is waterproof and can be submerged up to 2 meters for 30 minutes.

Water droplets may condense under the display cover if the phone is immersed in water with a significant drop in temperature. This does not indicate water leakage and the droplets will disappear when the display reaches room temperature.

The Sonim XP5900 is dust-resistant, rugged and shock-resistant. However, it is not dust-proof or unbreakable if subjected to overwhelming impact. For best results and long product life, one should protect the Sonim XP5900 from salt water, dust and strong impacts.

switch off the device or deactivate the RF transmitter when required, especially when posted in hospitals and airplanes. Equipment used in these places may be sensitive to radio waves emitted from the device and adversely affect their operation. Also, observe restrictions at gas stations or other areas with flammable atmosphere or when close to electro-explosive devices.

CHILD SAFETY

Do not allow children to play with your mobile phone or its accessories. Keep it out of their reach. They could hurt themselves or others, or could accidentally damage the mobile phone or accessories. Your mobile phone and its accessories may contain small parts, which could be detached and create a choking hazard.

EMERGENCY CALLS

Mobile phones operate using radio signals, which cannot guarantee connection under all conditions. Therefore you should never rely solely upon any mobile phone for essential communications (e.g. medical emergencies). Emergency calls may not be possible in all areas, on all cellular networks, or when certain network services and/or mobile phone features are in use. Check with your local service provider.

AVOID EXTREME TEMPERATURE

Leaving the device in hot or cold places, such as in a closed car in summer or winter conditions, reduces the capacity and lifetime of the battery. For the best results, try to use the device between -20°C and $+55^{\circ}\text{C}$ (-4°F and 131°F). If your battery is very hot or very cold, your device may be temporarily disabled, even if the battery is fully charged.

PERSONAL MEDICAL DEVICES

Mobile phones may affect the operation of cardiac pacemakers and other implanted equipment. Please avoid placing the mobile phone over the pacemaker, for example in your breast pocket. When using the mobile phone, place it at the ear opposite the pacemaker. If a minimum distance of 15 cm (6 inches) is kept between the mobile phone and the pacemaker, the risk of interference is limited. If you suspect that interference is taking place, immediately turn off your mobile phone. Contact your cardiologist for more information. For other medical devices, consult your physician and the manufacturer of the device. Comply with instructions to



BATTERY USAGE

Your Sonim XP5plus phone comes with a removable battery. For any battery related queries, contact Sonim Support at 1-833-MY-SONIM (1-833-697-6646) or support@sonimtech.com.

- Use only a Sonim XP5900 certified battery (BAT-03500-01S supplied by Zhongshan Tianmao Battery Co., Ltd) that is designed for this phone model.
- The use of other batteries may cause permanent damage to your device, thus voiding the warranty.
- It is recommended to protect the battery from extreme temperature environments and moisture.
- Please keep the battery out of the reach of children.

VERIFYING AND OPTIMIZING BATTERY USAGE

You can check the battery usage status and also close some applications to save battery power. From the application screen, select **Settings** () > **Battery** ().

The current battery level (charging or not charging) is displayed in the middle of the screen just below the Date information. Select **Settings** () > **Battery** () to view the discharge graph which shows the battery level over time since you last charged the device, and how long you have been running on battery power.

The list at the bottom of the screen shows the breakdown of battery usage for individual apps and services. Select any listed items for more details. The details screen for some apps includes buttons that allow you to adjust settings affecting power usage, or stop the application completely.



If you Force Stop an application, it may affect the overall performance of not only that application, but the device as well. If you notice any issues with device performance, please power cycle the device.

TIPS TO EXTEND THE BATTERY LIFE

Follow these tips to extend your phone's battery life.

- If you are not using Wi-Fi, Bluetooth, or GPS, use the **Settings** to turn them off. The GPS setting is located in **Settings > Location**.
- Set screen brightness to **Low** and set a shorter Sleep timeout (15 seconds). The display settings are located in **Settings > Display**.
- If you are traveling and do not have access to mobile data or Wi-Fi network, switch to Airplane mode. Select **Airplane mode** from **Quick Settings**.

CHARGING THE BATTERY

We recommend that you give your device a full charge before you use your device for the first time.



The ambient temperature during charging shall be in the range 0°C to 45°C (32°F to 113°F)



Only the power supplies with outputs meeting the SELV requirements can be used for charging. The maximum allowable input voltage for the phone is 5V.



There is a risk of explosion while charging if the battery has been replaced by an incorrect type.



If the battery is completely out of charge, it can take several minutes for the charging icon to appear when the charger is connected.

PROPERLY CHARGING THE DEVICE

1. INSERT CHARGER

Insert the charger plug into a power outlet.

2. CONNECT TO THE PHONE

The charging port is located on the right side of the phone. Open the port cover and insert the charging connector to the charging port.

3. CHARGING ANIMATION/ICON

- If the battery is being charged when the phone is switched off, a battery charging animation with current battery level is displayed.
- If the battery is being charged while the phone is switched on, the battery icon on the status bar shows the animation indicating that the battery is being charged.
- After the battery is fully charged the charging animation stops and you can disconnect the charger from the phone. A message is displayed as **Battery is full**. Please unplug the charger.



STORING YOUR PHONE OR BATTERY

If you plan to store your phone or your battery for an extended time, please follow the recommendations below to ensure long battery life and minimize battery self-discharge:

- Charge your battery to a level between 40% to 80%
- Store phone and battery separately to minimize battery trickle drain
- Insulate the battery terminals to avoid discoloration and potential short circuits with other battery terminals
- Store the battery in dry and cool conditions in a vibration-free environment
- If you use a climate-controlled storage location, set the temperature to 50° to 64° F (10° - 18° Celsius) and keep the relative humidity between 40% - 50%
- Recharge the battery once every 6 months, using the original Sonim wall charger and charging cable

GUIDELINE FOR HEADPHONE AND EARPHONE USAGE

To prevent possible hearing damage, please do not listen at high volume levels for long periods.

HAC RATING

The FCC has created a rating system for cellular phones regarding their HAC-related performance. This rating helps consumers with hearing disabilities to find phones that work well with their hearing aid devices. The HAC rating and measurement procedure are described in the American National Standards Institute (ANSI C63.19-2011) contains two rating standards: an “M” rating from 1 to 4 for hearing aids operating in microphone mode, and a “T” rating from 1 to 4 for hearing aids operating in telecoil mode. M-Rating stands for Microphone rating and indicates the amount of reduction of RF interference between the telephone and the hearing aid in acoustic coupling mode (also called microphone mode). Phones rated M3 or M4 meet FCC requirements and generate less interference to hearing devices set in microphone mode. T-Rating stands for telecoil rating and represents inductive coupling with hearing aids that are operating in telecoil mode. A telecoil is a small piece of tightly wrapped wire, built into some hearing aids. While the microphone of a hearing aid picks up all sounds, the telecoil only picks up an electromagnetic signal from the telephone. Thus, users of telecoil-equipped hearing aids are able to communicate over the telephone without the amplification of unwanted background noise.

Phones rated T3 or T4 meet FCC requirements and generate less interference to hearing devices set in telecoil mode. A combination of M-rating and T-rating defines the final HAC rating and is a deciding factor in selecting cellular phones for people with hearing problems. A HAC compliant phone could be rated:

- M3/T3
- M3/T4
- M4/T3
- M4/T4

Its resistance to interference. The best way to evaluate the suitability of the phone is to try it with the intended hearing aid device.

The model XP5900 have been tested for hearing aid device compatibility and complies with the Federal Communications Commission (FCC) requirements.

These devices are rated M3/T4.

RADIO FREQUENCY ENERGY

This device meets the government’s requirements for exposure to radio waves.

This device is designed and manufactured not to exceed the emission limits for exposure to radio frequency (RF) energy set by the Federal Communications Commission of the U.S. Government.

The exposure standard for wireless device employs a unit of measurement known as the Specific Absorption Rate, or SAR. The SAR limit set by the FCC is 1.6W/kg. *Tests for SAR are conducted using standard operating positions accepted by the FCC with the device transmitting at its highest certified power level in all tested frequency bands. Although the SAR is determined at the highest certified power level, the actual SAR level of the device while operating can be well below the maximum value. This is because the device is designed to operate at multiple power levels so as to use only the power required to reach the network. In general, the closer you are to a wireless base station antenna, the lower the power output.

The highest SAR value for the model device XP5900 (Type number P14501 & P14601) as reported to the FCC:

- When tested for use at the ear is 0.82 W/kg, and
- When worn on the body, as described in this user guide, is 1.06 W/kg (Body-worn measurements differ among device models, depending upon available accessories and FCC requirements.)
- When device is set as Hotspot mode as described in this user guide, is 1.06 W/kg. While there may be differences between the SAR levels of various devices and at various positions, they all meet the government requirement.
- When device is set as Simultaneous Transmission mode, is 1.59 W/kg.

The FCC has granted an Equipment Authorization for this model device with all reported SAR levels evaluated as in compliance with the FCC RF exposure guidelines. SAR information on this model device is on file with the FCC and can be found under the Display Grant section of www.fcc.gov/oet/ea/fccid after searching on FCC ID: WYPP14510.

For body worn operation, this device has been tested and meets the FCC RF exposure guidelines for use with an accessory that contains no metal and be positioned a minimum of 10 mm from the body. When the device is set to hotspot mode, please use it at least 10 mm away from your body. Use of other accessories may not ensure compliance with FCC RF exposure guidelines.

FEDERAL COMMUNICATION COMMISSION INTERFERENCE STATEMENT

This device complies with part 15 of the FCC Rules. Operation is subject to the following two conditions:

- This device may not cause harmful interference, and
- This device must accept any interference received, including interference that may cause undesired operation.

This device has been tested and found to comply with the limits for a Class B digital device, pursuant to Part 15 of the FCC Rules. These limits are designed to provide reasonable protection against harmful interference in a residential installation. This equipment generates, uses, and can radiate radio frequency energy, and if not installed and used in accordance with the instructions, may cause harmful interference to radio communications. However, there is no guarantee that interference will not occur in a particular installation. If this equipment does cause harmful interference to radio or television reception, which can be determined by turning the equipment off and on, the user is encouraged to try to correct the interference by one or more of the following measures:

- Reorient or relocate the receiving antenna.
- Increase the separation between the equipment and receiver.
- Connect the equipment into an outlet on a circuit different from that to which the receiver is connected.
- Consult the dealer or an experienced radio/TV technician for help.

FCC COMPLIANCE STATEMENT

- Any changes or modifications not expressly approved by the party responsible for compliance could void the user's authority to operate the equipment.
- The antenna(s) used for this transmitter must not be co-located or operating in conjunction with any other antenna or transmitter.
- The country code selection is for non-US model only and is not available to all US model. Per FCC regulation, all Wi-Fi product marketed in US must be fixed to US operation channels only.

ISED RF EXPOSURE STATEMENT (IC)

This EUT is compliance with SAR for general population/uncontrolled exposure limits in IC RSS-102 and had been tested in accordance with the measurement methods and procedures specified in IEEE 1528 and IEC 62209. This equipment should be installed and operated with minimum distance 15 mm between the radiator and your body.

This device and its antenna(s) must not be co-located or operating in conjunction with any other antenna or transmitter.

Operations in the 5.15-5.25GHz band are restricted to indoor usage only.

Ce dispositif a été testé pour la conformité avec les valeurs SAR à un fonctionnement typique près du corps. Pour assurer que les niveaux d'exposition aux radiofréquences en deçà des niveaux testés, utiliser des accessoires avec cet équipement pour maintenir une distance de séparation minimale de 15 mm entre le corps de l'utilisateur et l'appareil. Lorsque l'appareil est réglé sur le mode point chaud, veuillez l'utiliser à au moins 10mm de votre corps. Ces accessoires ne doivent pas contenir des composants métalliques. Il est possible que les accessoires utilisés près du corps qui ne répondent pas à ces exigences ne sont pas compatibles avec les limites SAR et il est conseillé d'éviter de les utiliser.

Les opérations dans la bande de 5.15-5.25GHz sont limitées à un usage intérieur seulement

This device complies with Industry Canada license-exempt RSS standard(s). Operation is subject to the following two conditions:

1. This device may not cause interference.
2. This device must accept any interference, including interference that may cause undesired operation of the device.

et appareil est conforme avec Industrie Canada RSS exemptes de licence standard(s).

Son fonctionnement est soumis aux deux conditions suivantes:

- (1) cet appareil ne peut pas provoquer d'interférences, et
- (2) cet appareil doit accepter toute interférence, y compris celles pouvant causer un mauvais fonctionnement de l'appareil.

This Class B digital apparatus complies with Canadian CAN ICES-003(B) / NMB-003(B).

Cet appareil numérique de la classe B est conforme à la norme CAN ICES-003(B) / NMB-003(B) du Canada.

HAZARDOUS LOCATION USAGE

WARNINGS

Determine by inspection that the following information is made available to the user by one or more of:

1. Printed on the label for the battery.
2. Printed on the label for the host device.
3. Printed in the owner's manual.
4. Posted in a help file or Internet website.

 Do not disassemble or open crush, bend or deform, puncture or shred.

 Do not modify or re manufacture, attempt to insert foreign objects into the battery, immerse or expose to water or other liquids, expose to fire, explosion or other hazard.

 Only use the battery with a charging system that has been qualified by the system per CTIA Certification Requirements for Battery System Compliant to IEEE 1725. Use of an unqualified battery or charger may present a risk of fire, explosion, leakage or other hazard.

 Do not short circuit a battery or allow metallic conductive objects to contact battery terminals.

 Promptly dispose of used batteries in accordance with local regulations.

 Battery usage by children should be supervised.

 Avoid dropping the phone or battery. If the phone or battery is dropped, especially on a hard surface, and the user suspects damage, take it to a service center for inspection.

 Improper battery use may result in a fire, explosion or other hazard.

 IT IS NOT ALLOWED TO CONNECT ANY EXTERNAL DEVICES TO ALL PORTS/ INTERFACE (USB) IN A HAZARDOUS AREA.

 ONLY THE POWER SUPPLIES WITH OUTPUTS MEET THE SELV REQUIREMENTS CAN BE USED FOR CHARGING. THE MAXIMUM ALLOWABLE INPUT VOLTAGE FOR THE PHONE IS 5V.

 DO NOT USE THE NON-LPS ADAPTER TO CHARGE THE DEVICE. IT MAY CAUSE A FIRE.

 EXPLOSION HAZARD - THE BATTERY ONLY CAN BE CHARGED or CHANGED IN NON-HAZARDOUS LOCATION.
RISQUE D'EXPLOSION - LES PILE DOIVENT ETRE REMPLACEES OU CHARGE DANS NON-DANGEREUX EMPLACEMENT.

 DO NOT CONNECT OR DISCONNECT THROUGH USB PORT WHEN ENERGIZED, UNLESS THE LOCATION IS KNOWN TO BE NON-HAZARDOUS.

 DO NOT OPEN THE BATTERY COVER DOOR IN HAZARDOUS LOCATIONS.

 THE TORQUE FORCE OF BATTERY COVER SCREW is 2kgf.cm.

CERTIFICATION

cCSAus	CSA Certificate No. 80095697
	Class I, Division 2, Groups A, B, C and D, T4
	Class II, Division 2, Groups F and G, T4
	Class III, Division 2

INDEX

A

Alarm 37
Alerts 32
Applications 36

B

Backup 36
Browser 34

C

Call Settings 29
Contacts 27

D

Date & Time 25

E

Export 28

F

FCC 45
File Explorer 37
Flash 35
Forget Network 14

H

HAC 44
Hazardous Location 46

I

Import 28
ISED RF Exposure Statement 45

K

Keyboard Dictionaries 25
Knob Version Options 38

L

Location 23

M

Memory 7
Messages 31
Missed Events 13
Modify Network 14

N

Notification 21

P

Phone Specifications 5
Programmable Keys Additional Options 39

Q

Quick Settings 13

R

Restore 36

S

SAR 44
Scout 33
Search 12
Setup Wizard 33
SIP 29
Sound Recorder 37
Speed Dial 29
Storage
 Internal Share 22
Support 33

T

Text Entry 11

U

Utilities 33

V

Voice Commands 36

W

Wi-Fi 14

X

XP5plus 5

Z

Zoom in 35
Zoom out 35